











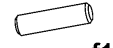

| | | | | |
|----|-----------|------|------|-----|
| 1 | S507-1003 | 1210 | 340 | 1/1 |
| 2 | S507-1004 | 1210 | 340 | 1/1 |
| 3 | S507-2003 | 400 | 363 | 1/1 |
| 4 | S507-3005 | 367 | 320 | 1/1 |
| 5 | S507-3006 | 367 | 320 | 1/1 |
| 6 | S507-3007 | 366 | 310 | 1/1 |
| 7 | S507-7003 | 736 | 396 | 1/1 |
| 8 | S507-7004 | 241 | 396 | 1/1 |
| 9 | S507-7802 | 255, | 396, | 1/1 |
| 10 | S507-9003 | 715 | 377 | 1/1 |
| 11 | S507-9004 | 282 | 377 | 1/1 |
| 12 | S507-9005 | 221 | 377 | 1/1 |

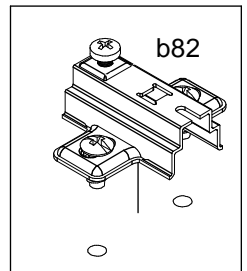
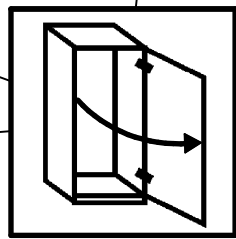
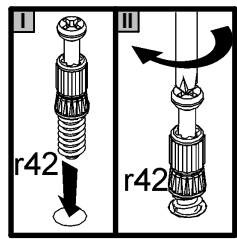
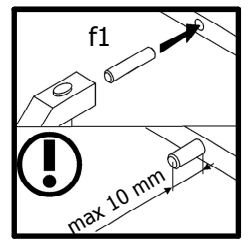
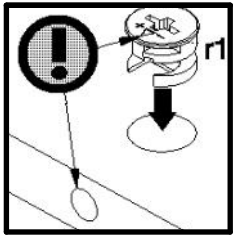
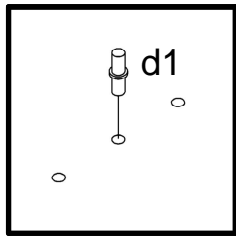
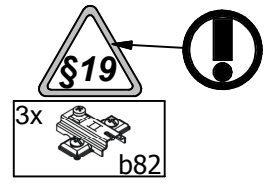
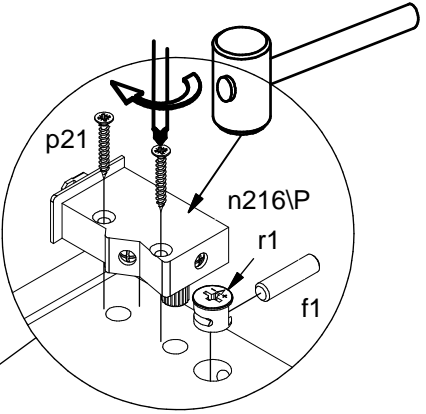
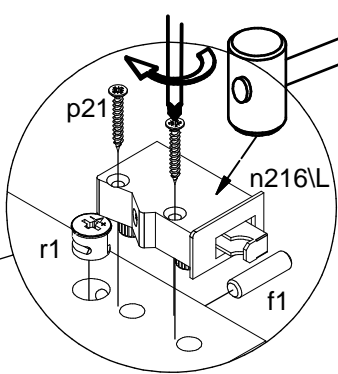
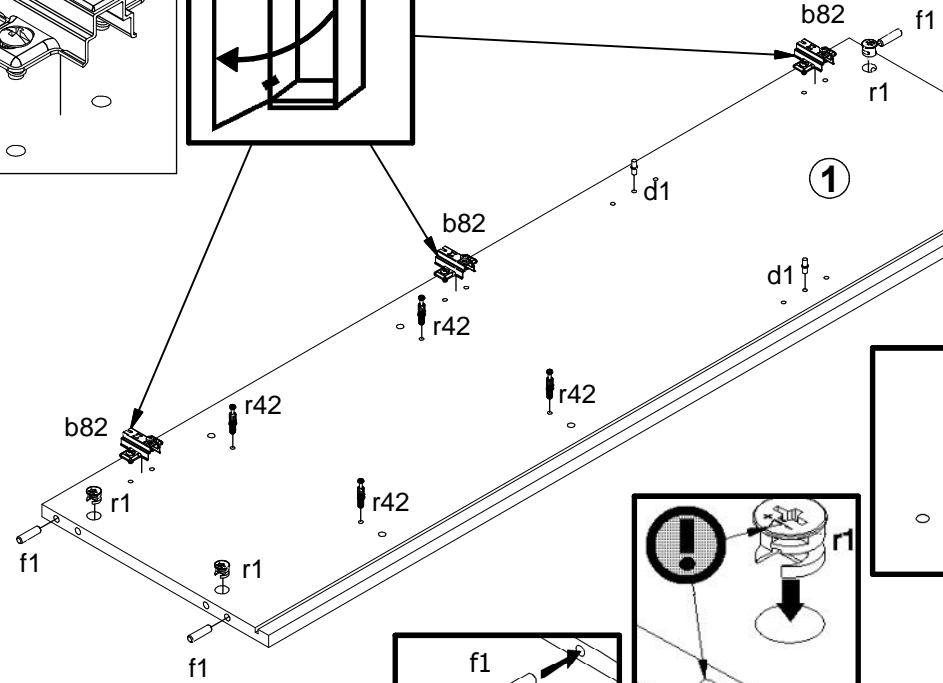
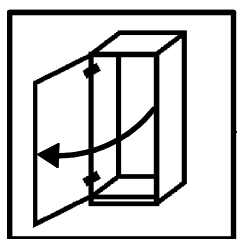
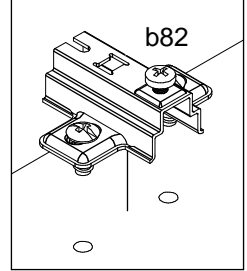
| | | |
|-----------------------------|--------------------------------|---------------------------------|
| 3x a158 | 1x a133 | 3x b82 |
| 1x 96mm c418 | 4x Ø5x17 mm d1 | 16x Ø8x30 mm f1 |
| 2x M4x25 mm j8 | 8x l2 | 6x 20x13x3,5/1 n108 |
| 1x n216/L | 1x n216/P | 4x Ø4x30 mm p21 |
| 6x Ø3,5x15 mm p51 | 6x Ø2,9x16 mm p55 | 2x Ø2x8 mm p123 |
| 8x Ø4x50 mm p150 | 16x Ø15x12 mm #16 r1 | 16x Ø10x12 mm #16 r42 |
| 16x Ø 20mm s68 | 3x Ø35x62x40x10 s71 | |
| 1x o86/1 | 1x o86/2 | 1x o80/3 |
| | | 1x o80/12 |
| 4x Ø10x50 mm f35 | 2x n217 | 4x Ø5x60 mm p17 |



- 2x  d1 $\varnothing 5 \times 17 \text{ mm}$
- 4x  r1 $\varnothing 15 \times 12 \text{ mm} \#16$
- 4x  f1 $\varnothing 8 \times 30 \text{ mm}$
- 1x  n216L
- 2x  p21 $\varnothing 4 \times 30 \text{ mm}$
- 4x  r42 $\varnothing 4 \times 30 \text{ mm}$

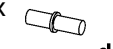

- 4x  r42 $\varnothing 4 \times 30 \text{ mm}$
- 2x  p21 $\varnothing 4 \times 30 \text{ mm}$
- 1x  n216P
- 2x  d1 $\varnothing 5 \times 17 \text{ mm}$
- 4x  r1 $\varnothing 15 \times 12 \text{ mm} \#16$
- 4x  f1 $\varnothing 8 \times 30 \text{ mm}$

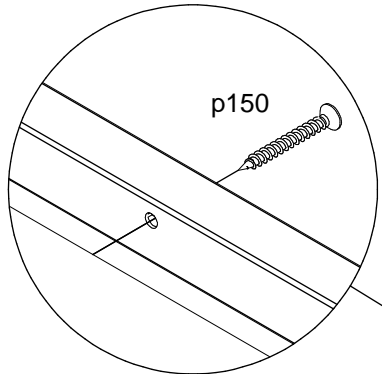
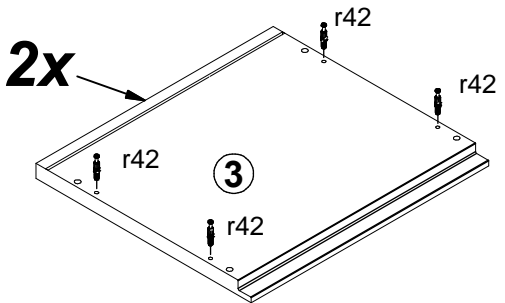
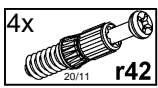
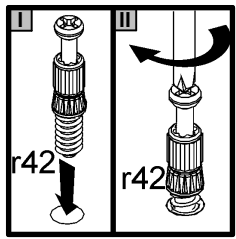

1

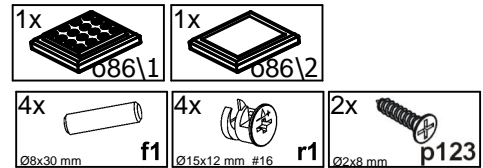
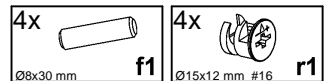
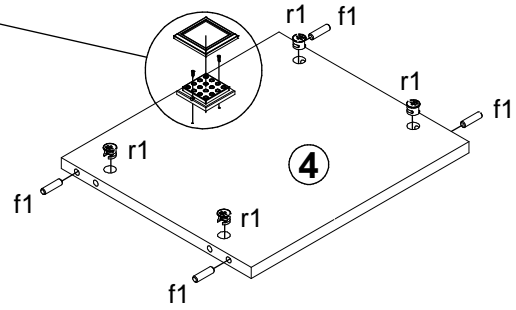
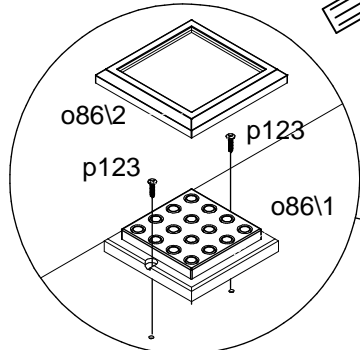
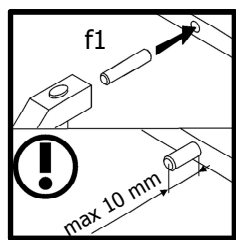
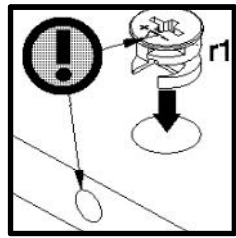
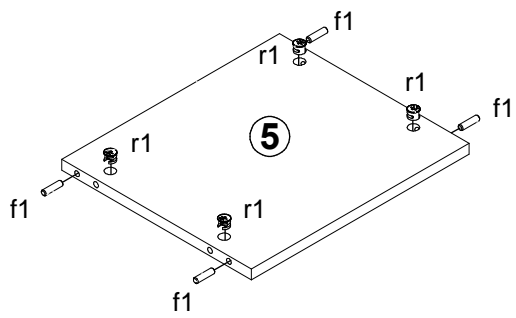
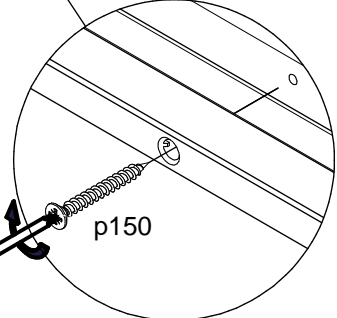
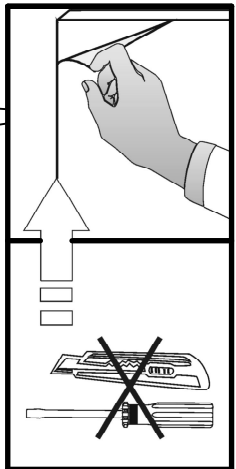
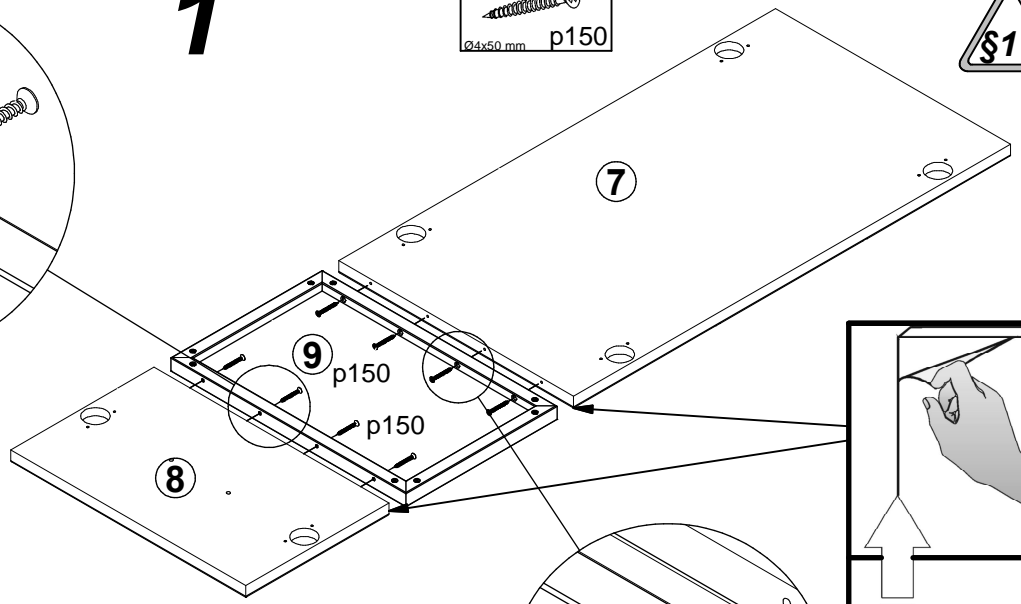
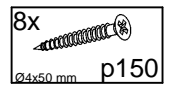

A

S507-SFW1W/13/4



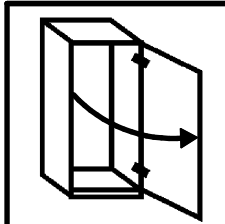

10 H9 -- 10

5 / 9

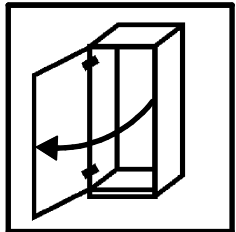
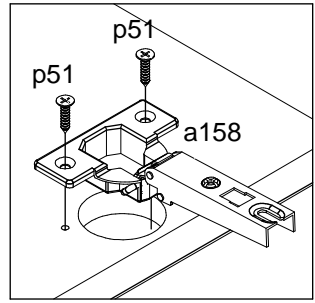
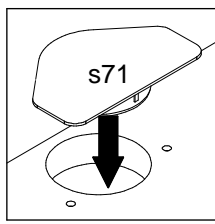
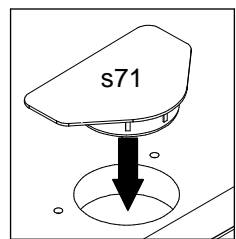
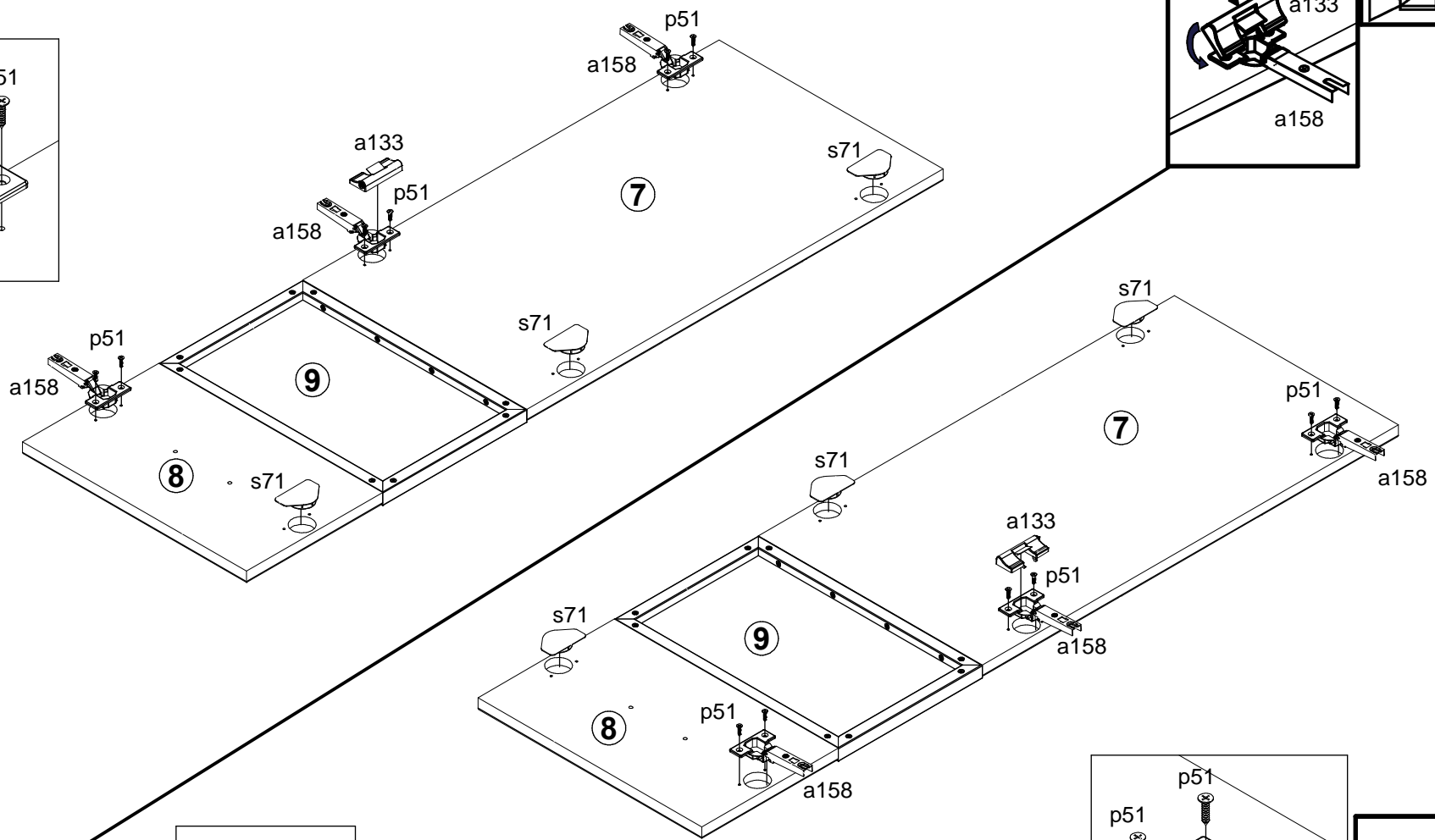
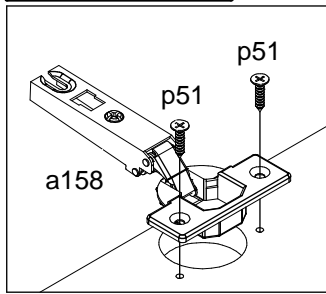
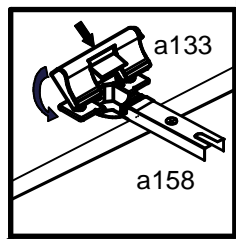
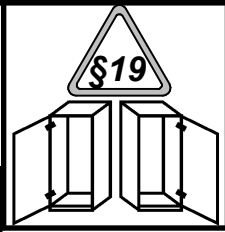

1



- 3x  a158
 - 1x  a133
 - 6x  p51
 - 3x  s71
- Ø3,5x15 mm

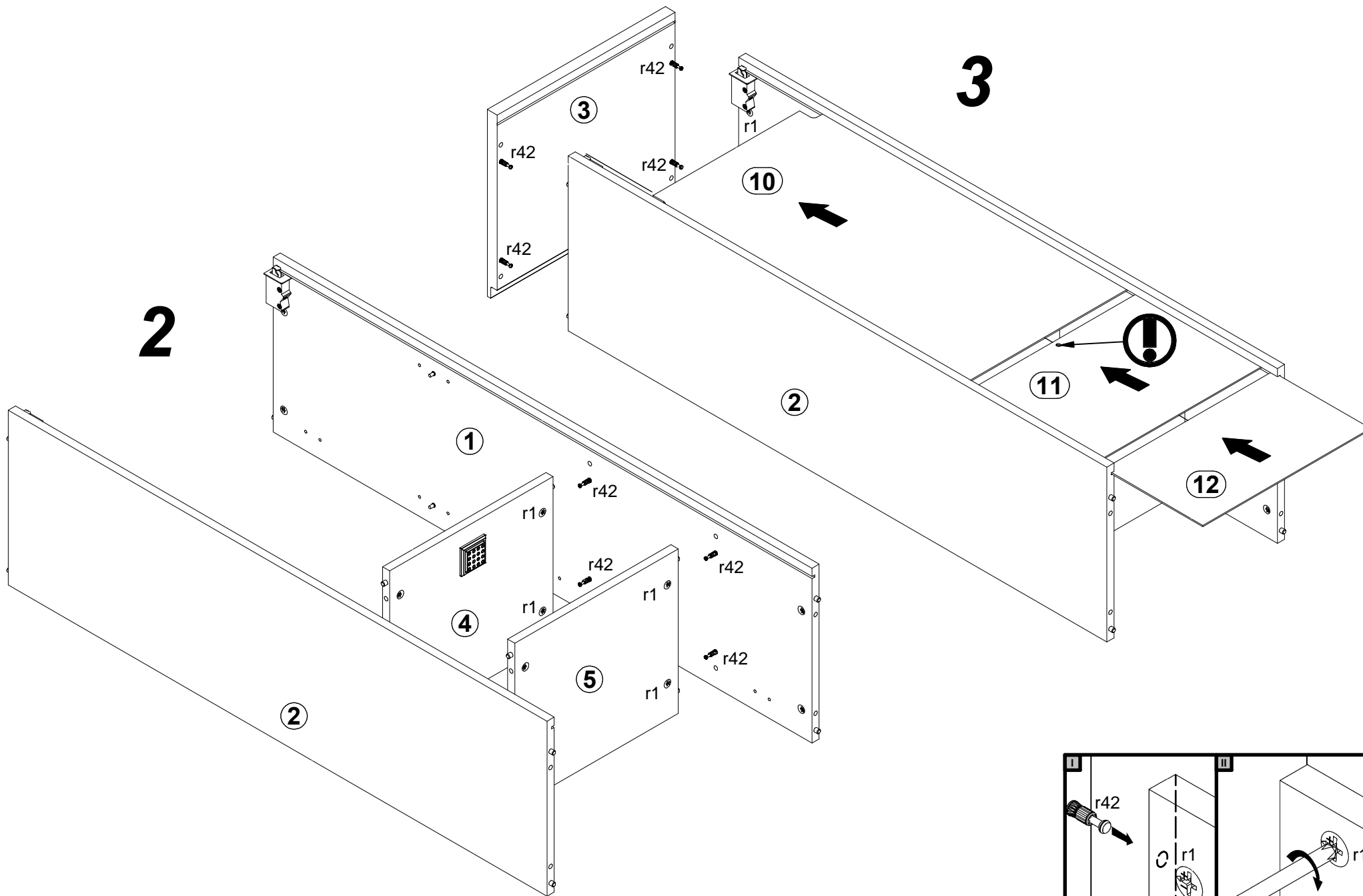

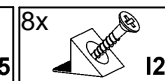
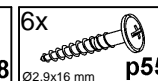
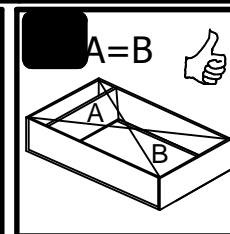
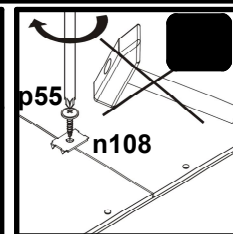
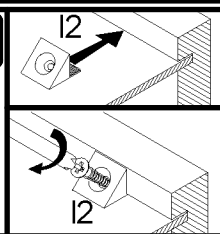
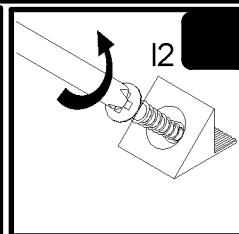
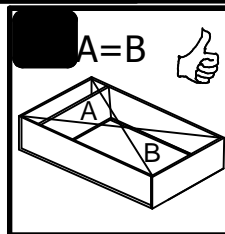

4

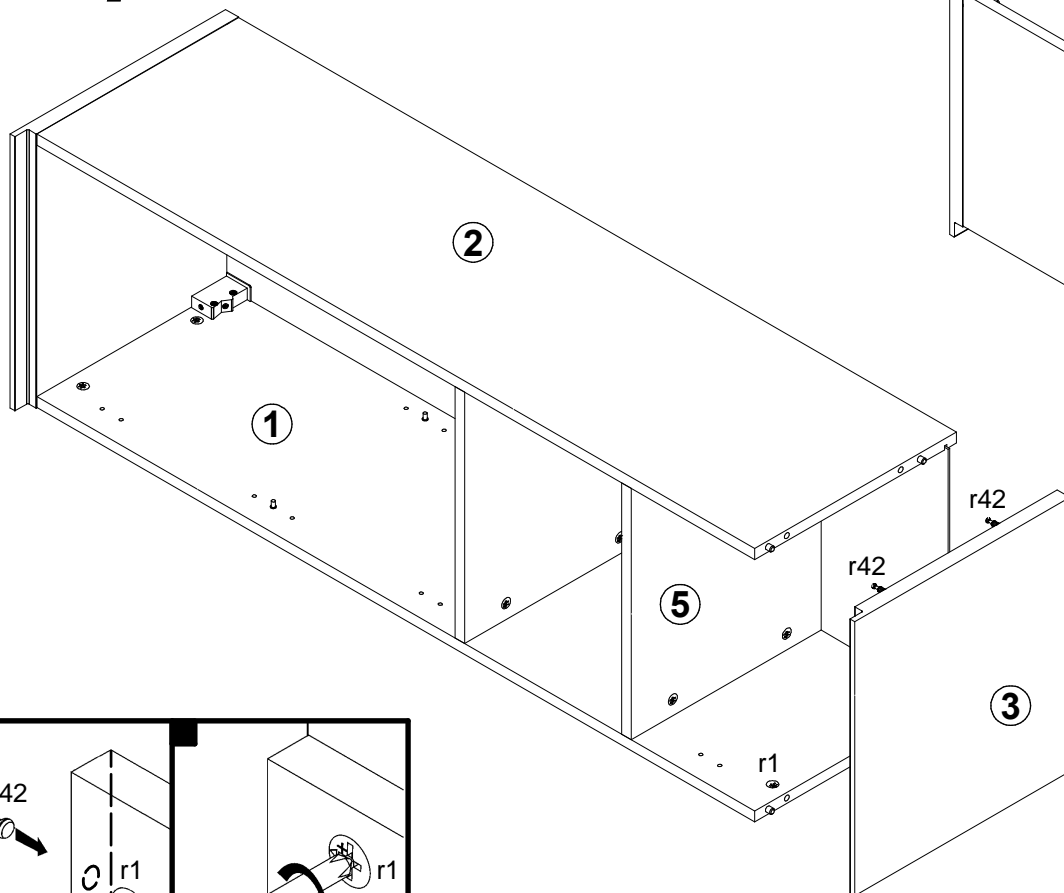

5

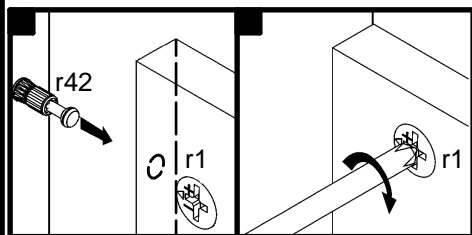
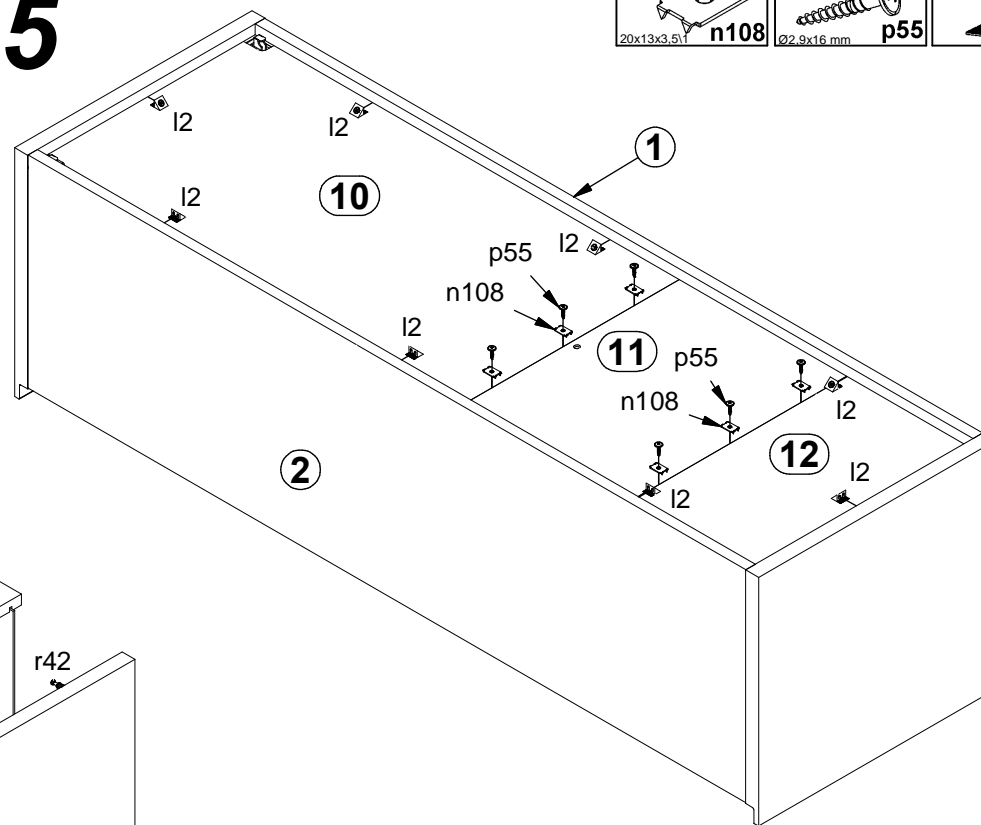

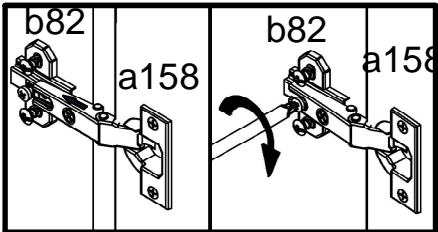

6

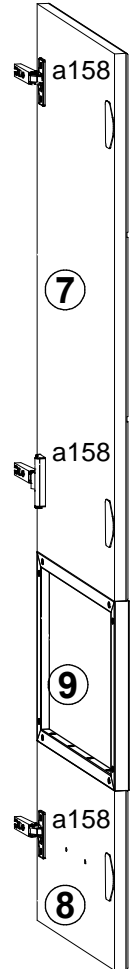
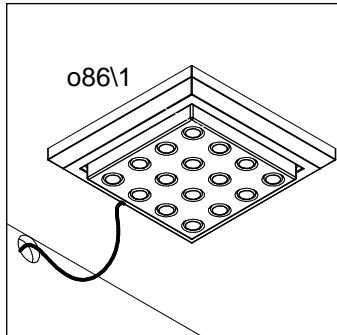
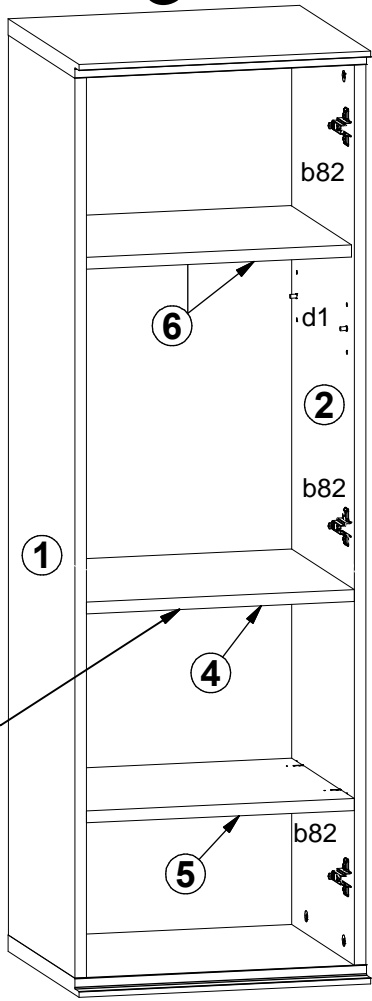

7

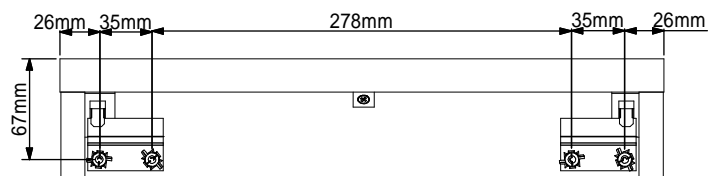
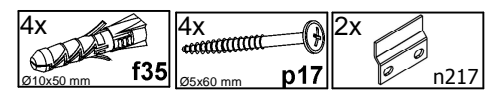
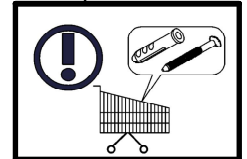
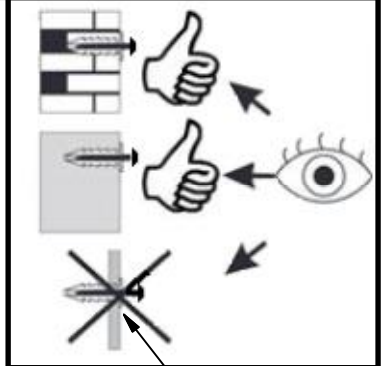
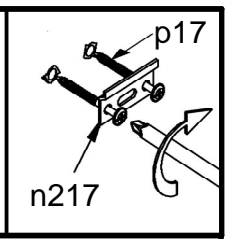
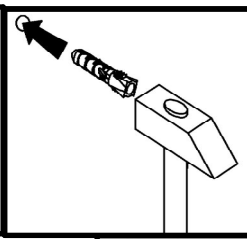
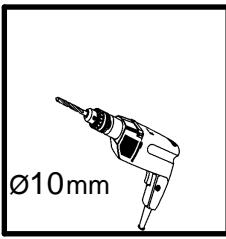
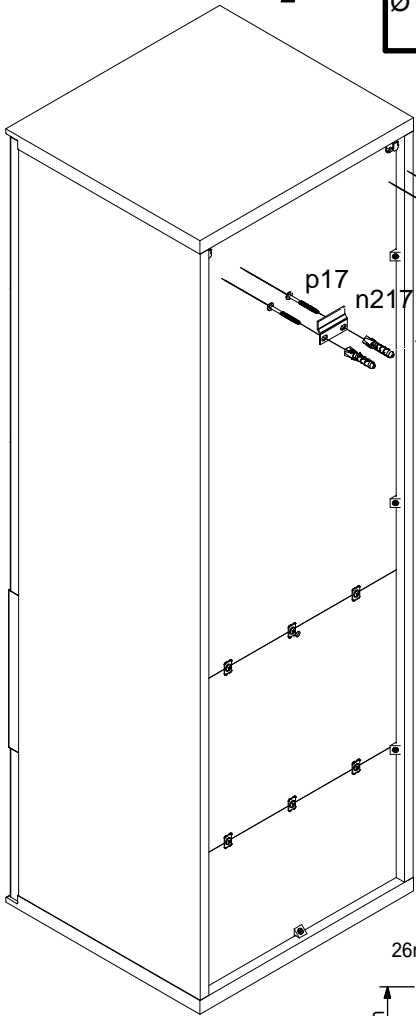

8

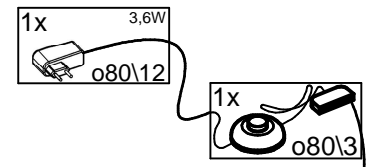
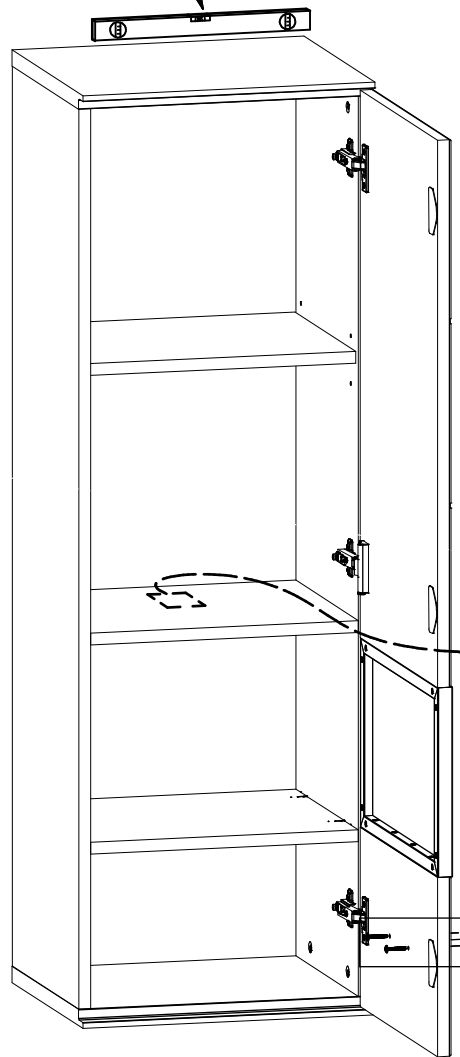
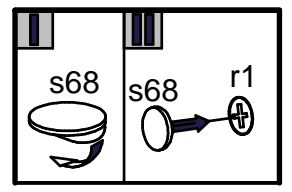
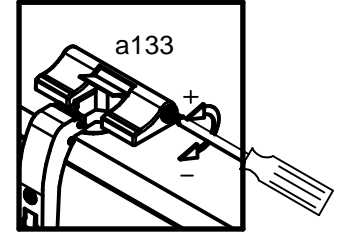
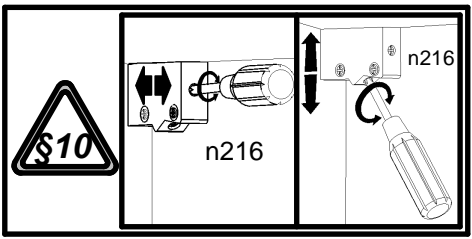
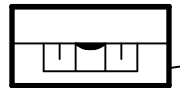

o86\1

- 1x 96mm c418
- 2x M4x25 mm j8
- 16x Ø 20mm s68
- 1x 3.6W o80\3
- 1x 3.6W o80\12

